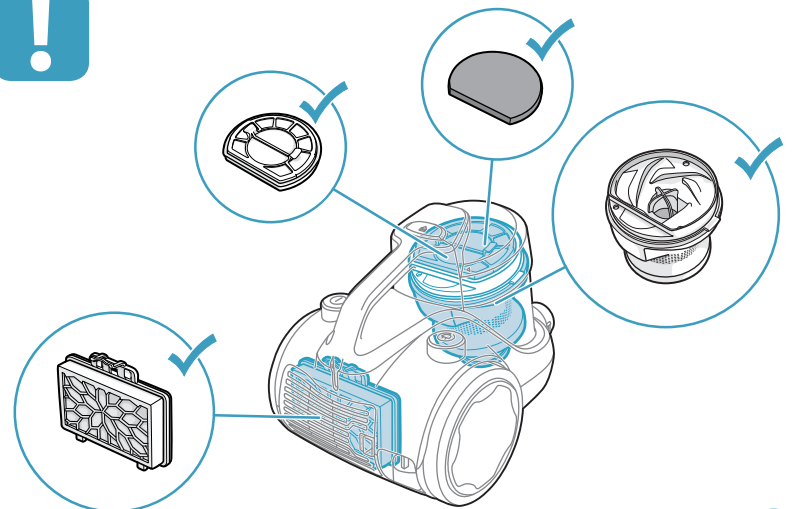
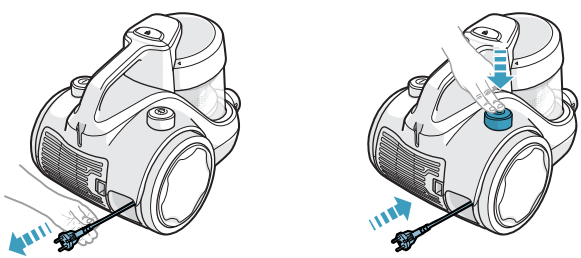
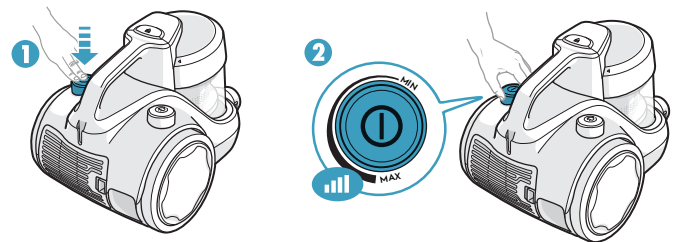
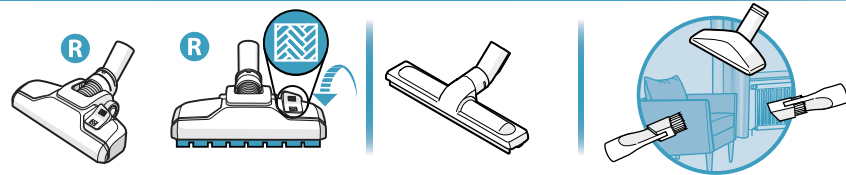
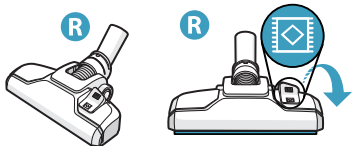
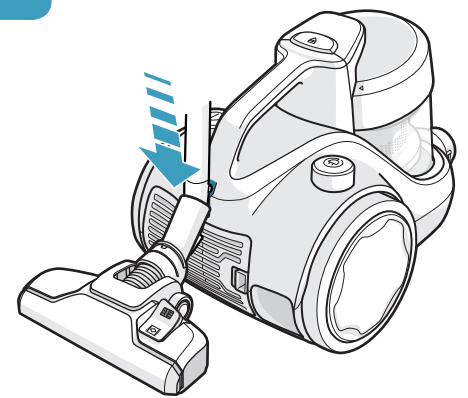
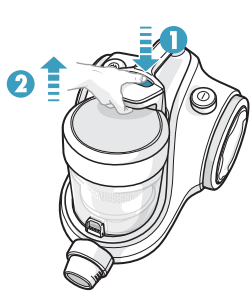
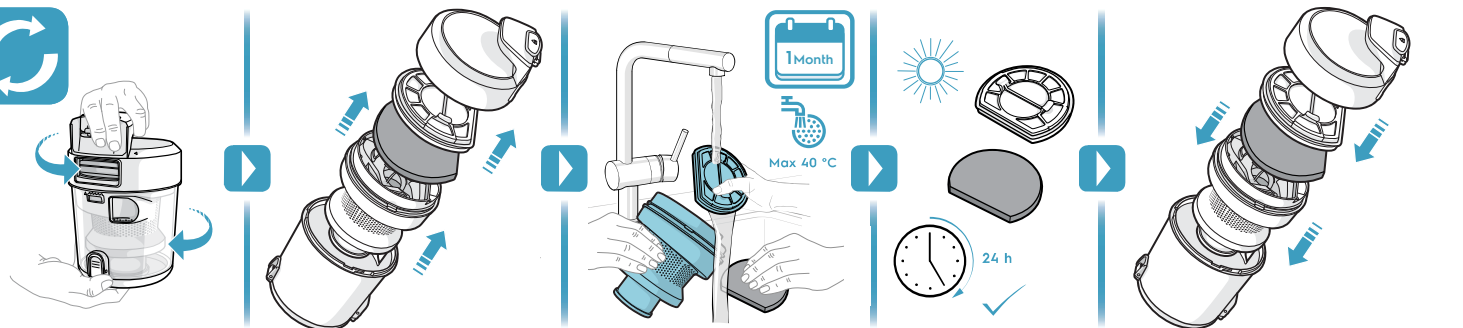
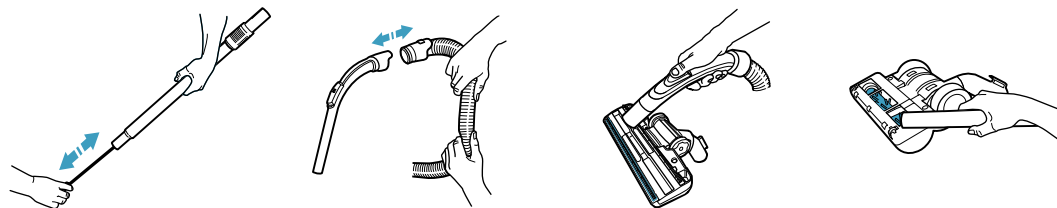
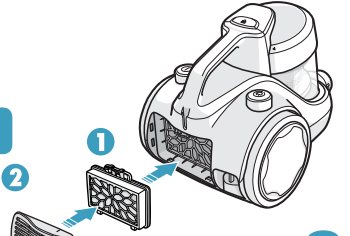
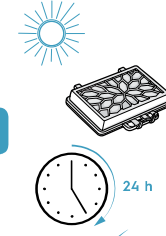
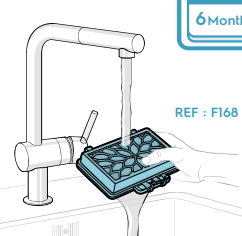
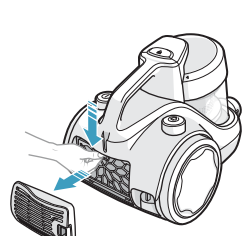
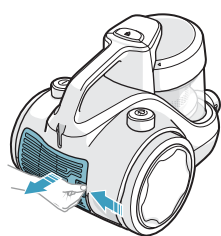

**1**

\* Certain models only | Suivant les modèles | فقط بعض الموديلات | Само определени модели | Pouze u některých modelů | Nur bestimmte Modelle  
 Kun på visse modeller | Ainult kindlad mudelid | Solo algunos modelos | فقط برای بعضی مدلها | Vain tietyt mallit | Ορισμένα μόνο μοντέλα  
 Samo određeni modeli | Csak egyes típusoknál | Solo per alcuni modelli | Tik tam tikriems modeliams | Tikai noteiktiem modeļiem | Kun enkelte modeller  
 Tylko niektóre modele | Doar pentru anumite modele | Только отдельные модели | Bara vissa modeller | Le določeni modeli | Len určité modely  
 Само код одређених модела | Yalnızca bazı modellerde | Залежно від моделі

**2**

**3**

**4**

**5**

**R** Recommended nozzle | Brosse recommandée | الفرشة الموصى بها | Препоръчителна дюза | Doporučená hubice | Empfohlene Düse | Anbefalet mundstykke  
 Soovituslik otsak | Cepillo recomendado | نازلهاى توصيه شده | Suositeltava suulake | Συνιστώμενο ακροφύσιο | Preporučeni nastavak | Ajánlott szívfőfej  
 Spazzola consigliata | Rekomenduojamas antgalis | Leteicams uzgalis | Anbefalt munnstykke | Zalecana dysza | Perie recomandată | Рекомендованная насадка  
 Rekomenderat munstykke | Priporočeni nastavek | Odporúčaná hubica | Препоручени наставак | Önerilen başlık | Рекомендована насадка

**6**

**7**

**8**

**9**

[www.electrolux.com/shop](http://www.electrolux.com/shop)